

# ADC08100

## 8-Bit, 20 Msps to 100 Msps, 1.3 mW/Msps A/D Converter

### General Description

The ADC08100 is a low-power, 8-bit, monolithic analog-to-digital converter with an on-chip track-and-hold circuit. Optimized for low cost, low power, small size and ease of use, this product operates at conversion rates of 20 Msps to 100 Msps with outstanding dynamic performance over its full operating range while consuming just 1.3 mW per MHz of clock frequency. That's just 130 mW of power at 100 Msps. Raising the PD pin puts the ADC08100 into a Power Down mode where it consumes just 1 mW.

The unique architecture achieves 7.4 Effective Bits with 41 MHz input frequency. The excellent DC and AC characteristics of this device, together with its low power consumption and single +3V supply operation, make it ideally suited for many imaging and communications applications, including use in portable equipment. Furthermore, the ADC08100 is resistant to latch-up and the outputs are short-circuit proof. The top and bottom of the ADC08100's reference ladder are available for connections, enabling a wide range of input possibilities. The digital outputs are TTL/CMOS compatible with a separate output power supply pin to support interfacing with 3V or 2.5V logic. The digital inputs (CLK and PD) are TTL/CMOS compatible. The output format is straight binary

The ADC08100 is offered in a 24-lead plastic package (TSSOP) and is specified over the industrial temperature range of  $-40^{\circ}\text{C}$  to  $+85^{\circ}\text{C}$ .

### Features

- Single-ended input
- Internal sample-and-hold function
- Low voltage (single +3V) operation
- Small package
- Power-down feature

### Key Specifications

- |                              |  |
|------------------------------|--|
| ■ Resolution                 | 8 bits   |
| ■ Maximum sampling frequency | 100 Msps (min)                                     |
| ■ DNL                        | 0.4 LSB (typ)                                      |
| ■ ENOB                       | 7.4 bits (typ) at $f_{\text{IN}} = 41 \text{ MHz}$ |
| ■ THD                        | -60 dB (typ)                                       |
| ■ Power Consumption          |  |
| — Operating                  | 1.3 mW/Msps (typ)                                  |
| — Power down:                | 1 mW (typ)   |

### Applications

- Flat panel displays
- Projection systems
- Set-top boxes
- Battery-powered instruments
- Communications
- Medical scan converters
- X-ray imaging
- High speed Viterbi decoders
- Astronomy

### Pin Configuration

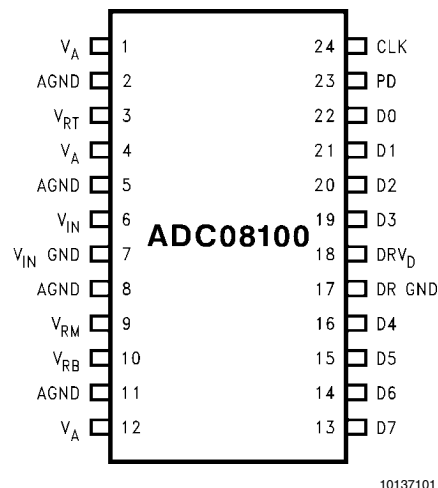

## Ordering Information

Order Number	Temperature Range	Package
ADC08100CIMTC	$-40^{\circ}\text{C} \leq T_A \leq +85^{\circ}\text{C}$	TSSOP
ADC08100CIMTCX	$-40^{\circ}\text{C} \leq T_A \leq +85^{\circ}\text{C}$	TSSOP (tape and reel)

## Block Diagram

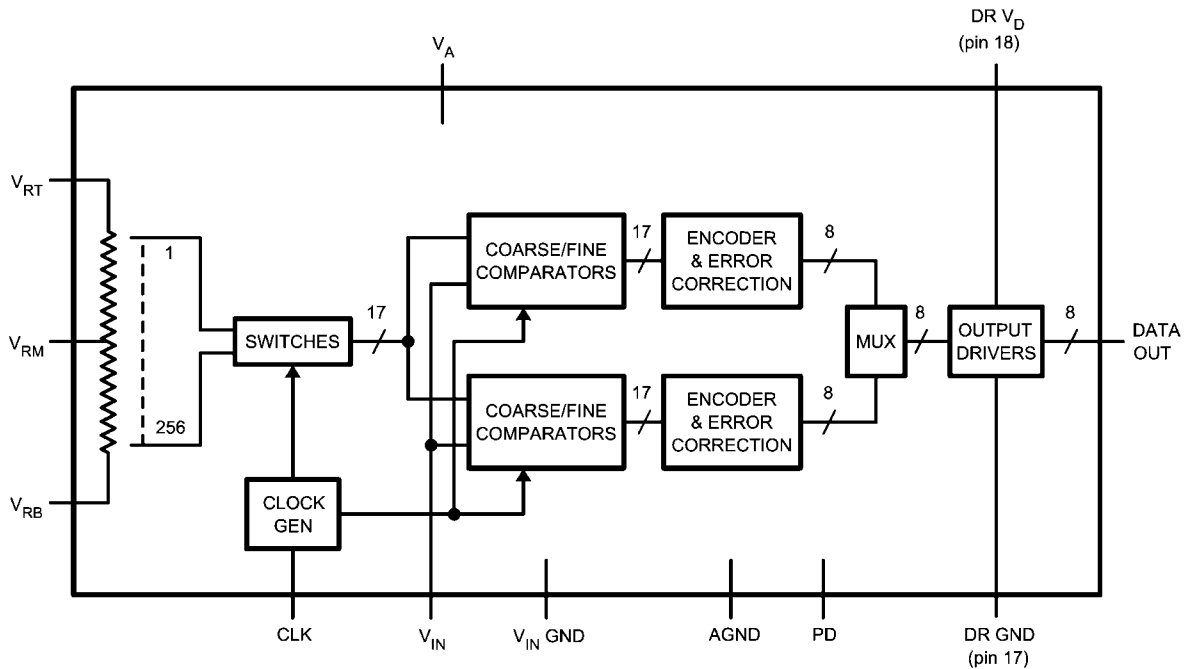

10137102

## Pin Descriptions and Equivalent Circuits

Pin No.	Symbol	Equivalent Circuit	Description
6	$V_{IN}$		Analog signal input. Conversion range is $V_{RB}$ to $V_{RT}$ .
3	$V_{RT}$		Analog Input that is the high (top) side of the reference ladder of the ADC. Nominal range is 1.0V to $V_A$ . Voltage on $V_{RT}$ and $V_{RB}$ inputs define the $V_{IN}$ conversion range. Bypass well. See Section 2.0 for more information.
9	$V_{RM}$		Mid-point of the reference ladder. This pin should be bypassed to a clean, quiet point in the analog ground plane with a 0.1 $\mu\text{F}$ capacitor.
10	$V_{RB}$		Analog Input that is the low side (bottom) of the reference ladder of the ADC. Nominal range is 0.0V to $(V_{RT} - 1.0\text{V})$ . Voltage on $V_{RT}$ and $V_{RB}$ inputs define the $V_{IN}$ conversion range. Bypass well. See Section 2.0 for more information.

Pin No.	Symbol	Equivalent Circuit	Description
23	PD		Power Down input. When this pin is high, the converter is in the Power Down mode and the data output pins hold the last conversion result.
24	CLK		CMOS/TTL compatible digital clock Input. $V_{IN}$ is sampled on the falling edge of CLK input.
13 thru 16 and 19 thru 22	D0–D7		Conversion data digital Output pins. D0 is the LSB, D7 is the MSB. Valid data is output just after the rising edge of the CLK input.
7	$V_{IN}$ GND		Reference ground for the single-ended analog input, $V_{IN}$ .
1, 4, 12	$V_A$		Positive analog supply pin. Connect to a clean, quiet voltage source of +3V. $V_A$ should be bypassed with a 0.1 $\mu$ F ceramic chip capacitor for each pin, plus one 10 $\mu$ F capacitor. See Section 3.0 for more information.
18	DR $V_D$		Power supply for the output drivers. If connected to $V_A$ , decouple well from $V_A$ .
17	DR GND		The ground return for the output driver supply.
2, 5, 8, 11	AGND		The ground return for the analog supply.

## Absolute Maximum Ratings

(Notes 1, 2)

If Military/Aerospace specified devices are required, please contact the National Semiconductor Sales Office/Distributors for availability and specifications.

Supply Voltage ( $V_A$ )	3.8V
Driver Supply Voltage (DR $V_D$ )	$V_A + 0.3V$
Voltage on Any Input or Output Pin	-0.3V to $V_A$
Reference Voltage ( $V_{RT}$ , $V_{RB}$ )	$V_A$ to AGND
CLK, $\overline{OE}$ Voltage Range	-0.3V to ( $V_A + 0.3V$ )
Digital Output Voltage ( $V_{OH}$ , $V_{OL}$ )	DR GND to DR $V_D$
Input Current at Any Pin (Note 3)	$\pm 25$ mA
Package Input Current (Note 3)	$\pm 50$ mA
Power Consumption at $T_A = 25^\circ\text{C}$	See (Note 5)
ESD Susceptibility (Note 6)	
Human Body Model	2500V
Machine Model	250V
Soldering Temperature, Infrared, 10 seconds (Note 7)	235°C
Storage Temperature	-65°C to +150°C

## Operating Ratings (Notes 1, 2)

Operating Temperature Range	$-40^\circ\text{C} \leq T_A \leq +85^\circ\text{C}$
Supply Voltage ( $V_A$ )	+2.7V to +3.6V
Driver Supply Voltage (DR $V_D$ )	+2.4V to $V_A$
Ground Difference IGND - DR GND1	0V to 300 mV
Upper Reference Voltage ( $V_{RT}$ )	1.0V to ( $V_A + 0.1V$ )
Lower Reference Voltage ( $V_{RB}$ )	0V to ( $V_{RT} - 1.0V$ )
$V_{IN}$ Voltage Range	$V_{RB}$ to $V_{RT}$

## Converter Electrical Characteristics

The following specifications apply for  $V_A = \text{DR } V_D = +3.0V_{DC}$ ,  $V_{RT} = +1.9V$ ,  $V_{RB} = 0.3V$ ,  $C_L = 10$  pF,  $f_{CLK} = 100$  MHz at 50% duty cycle. **Boldface limits apply for  $T_J = T_{MIN}$  to  $T_{MAX}$** : all other limits  $T_J = 25^\circ\text{C}$  (Notes 8, 9)

Symbol	Parameter	Conditions	Typical (Note 10)	Limits (Note 10)	Units (Limits)
<b>DC ACCURACY</b>					
	Resolution with no missing codes			<b>8</b>	Bits
INL	Integral Non-Linearity		$\pm 0.5$	<b><math>\pm 1.3</math></b>	LSB (max)
DNL	Differential Non-Linearity		$\pm 0.4$	<b>+1.0</b> <b>-0.95</b>	LSB (max) LSB (min)
FSE	Full Scale Error		18	$\pm 28$	mV (max)
$V_{OFF}$	Zero Scale Offset Error		26	$\pm 35$	mV (max)
<b>ANALOG INPUT AND REFERENCE CHARACTERISTICS</b>					
$V_{IN}$	Input Voltage		1.6	$V_{RB}$	V (min)
				$V_{RT}$	V (max)
$C_{IN}$	$V_{IN}$ Input Capacitance	$V_{IN} = 0.75V + 0.5 V_{rms}$	(CLK LOW)	3	pF
			(CLK HIGH)	4	pF
$R_{IN}$	$R_{IN}$ Input Resistance		>1		M $\Omega$
BW	Full Power Bandwidth		200		MHz
$V_{RT}$	Top Reference Voltage		1.9	$V_A$	V (max)
				1.0	V (min)
$V_{RB}$	Bottom Reference Voltage		0.3	$V_{RT} - 1.0$	V (max)
				0	V (min)
$V_{RT} - V_{RB}$	Reference Delta		1.6	1.0	V (min)
				2.3	V (max)
$R_{REF}$	Reference Ladder Resistance	$V_{RT}$ to $V_{RB}$	220	<b>150</b>	$\Omega$ (min)
				<b>300</b>	$\Omega$ (max)
$I_{REF}$	Reference Ladder Current		7.3	<b>5.3</b>	mA (min)
				<b>10.6</b>	mA (max)

Symbol	Parameter	Conditions	Typical (Note 10)	Limits (Note 10)	Units (Limits)
<b>CLK, PD DIGITAL INPUT CHARACTERISTICS</b>					
$V_{IH}$	Logical High Input Voltage	DR $V_D = V_A = 3.3V$		<b>2.0</b>	V (min)
$V_{IL}$	Logical Low Input Voltage	DR $V_D = V_A = 2.7V$		<b>0.8</b>	V (max)
$I_{IH}$	Logical High Input Current	$V_{IH} = DR V_D = V_A = 3.3V$	10		nA
$I_{IL}$	Logical Low Input Current	$V_{IL} = 0V, DR V_D = V_A = 2.7V$	-50		nA
$C_{IN}$	Logic Input Capacitance		3		pF
<b>DIGITAL OUTPUT CHARACTERISTICS</b>					
$V_{OH}$	High Level Output Voltage	$V_A = DR V_D = 2.7V, I_{OH} = -400 \mu A$	2.6	<b>2.4</b>	V (min)
$V_{OL}$	Low Level Output Voltage	$V_A = DR V_D = 2.7V, I_{OL} = 1.0 mA$	0.4	<b>0.5</b>	V (max)
<b>DYNAMIC PERFORMANCE</b>					
ENOB	Effective Number of Bits	$f_{IN} = 4 MHz, V_{IN} = -0.25 dBFS$	7.5		Bits
		$f_{IN} = 10 MHz, V_{IN} = -0.25 dBFS$	7.5	<b>7.0</b>	Bits (min)
		$f_{IN} = 41 MHz, V_{IN} = -0.25 dBFS, T_A = 25^\circ C$	7.3	6.9	Bits (min)
		$f_{IN} = 41 MHz, V_{IN} = -0.25 dBFS, T_A = T_{MIN}$ to $T_{MAX}$	7.3	<b>6.8</b>	Bits (min)
		$f_{IN} = 49.8 MHz, V_{IN} = -0.25 dBFS$	7.2		Bits
SINAD	Signal-to-Noise & Distortion	$f_{IN} = 4 MHz, V_{IN} = -0.25 dBFS$	47		dB
		$f_{IN} = 10 MHz, V_{IN} = -0.25 dBFS$	47	<b>43.9</b>	dB (min)
		$f_{IN} = 41 MHz, V_{IN} = -0.25 dBFS, T_A = 25^\circ C$	46	43.3	dB (min)
		$f_{IN} = 41 MHz, V_{IN} = -0.25 dBFS, T_A = T_{MIN}$ to $T_{MAX}$	46	<b>42.7</b>	dB (min)
		$f_{IN} = 49.8 MHz, V_{IN} = -0.25 dBFS$	45		dB
SNR	Signal-to-Noise Ratio	$f_{IN} = 4 MHz, V_{IN} = -0.25 dBFS$	47		dB
		$f_{IN} = 10 MHz, V_{IN} = -0.25 dBFS$	47	<b>44</b>	dB (min)
		$f_{IN} = 41 MHz, V_{IN} = -0.25 dBFS$	46.5	<b>42.8</b>	dB (min)
		$f_{IN} = 49.8 MHz, V_{IN} = -0.25 dBFS$	45.8		dB
SFDR	Spurious Free Dynamic Range	$f_{IN} = 4 MHz, V_{IN} = -0.25 dBFS$	61		dBc
		$f_{IN} = 10 MHz, V_{IN} = -0.25 dBFS$	60		dBc
		$f_{IN} = 41 MHz, V_{IN} = -0.25 dBFS$	63		dBc
		$f_{IN} = 49.8 MHz, V_{IN} = -0.25 dBFS$	54		dBc
THD	Total Harmonic Distortion	$f_{IN} = 4 MHz, V_{IN} = -0.25 dBFS$	-61		dBc
		$f_{IN} = 10 MHz, V_{IN} = -0.25 dBFS$	-60		dBc
		$f_{IN} = 41 MHz, V_{IN} = -0.25 dBFS$	-60		dBc
		$f_{IN} = 49.8 MHz, V_{IN} = -0.25 dBFS$	-54		dBc
HD2	2nd Harmonic Distortion	$f_{IN} = 4 MHz, V_{IN} = -0.25 dBFS$	-62		dBc
		$f_{IN} = 10 MHz, V_{IN} = -0.25 dBFS$	-60		dBc
		$f_{IN} = 41 MHz, V_{IN} = -0.25 dBFS$	-63		dBc
		$f_{IN} = 49.8 MHz, V_{IN} = -0.25 dBFS$	-54		dBc
HD3	3rd Harmonic Distortion	$f_{IN} = 4 MHz, V_{IN} = FS - 0.25 dB$	-68		dBc
		$f_{IN} = 10 MHz, V_{IN} = -0.25 dBFS$	-65		dBc
		$f_{IN} = 41 MHz, V_{IN} = -0.25 dBFS$	-64		dBc
		$f_{IN} = 49.8 MHz, V_{IN} = -0.25 dBFS$	-68		dBc
IMD	Intermodulation Distortion	$f_1 = 9 MHz, V_{IN} = -6.25 dBFS$ $f_2 = 10 MHz, V_{IN} = -6.25 dBFS$	-48		dBc

Symbol	Parameter	Conditions	Typical (Note 10)	Limits (Note 10)	Units (Limits)
<b>POWER SUPPLY CHARACTERISTICS</b>					
$I_A$	Analog Supply Current	DC Input	41	50	mA (max)
		$f_{IN} = 10 \text{ MHz}, V_{IN} = -3 \text{ dBFS}$	41		mA (max)
DR $I_D$	Output Driver Supply Current	DC Input	1	2	mA (max)
		$f_{IN} = 10 \text{ MHz}, V_{IN} = -3 \text{ dBFS}$	8		mA (max)
$I_A +$ DR $I_D$	Total Operating Current	DC Input	42	52	mA (max)
		$f_{IN} = 10 \text{ MHz}, V_{IN} = -3 \text{ dBFS}, \text{PD} = \text{Low}$	49		
		CLK Low, PD = Hi	0.2		
PC	Power Consumption	DC Input	126	<b>156</b>	mW (max)
		$f_{IN} = 10 \text{ MHz}, V_{IN} = -3 \text{ dBFS}, \text{PD} = \text{Low}$	147		mW
		CLK Low, PD = Hi	0.6		mW
PSRR <sub>1</sub>	Power Supply Rejection Ratio	FSE change with 2.7V to 3.3V change in $V_A$	54		dB
PSRR <sub>2</sub>	Power Supply Rejection Ratio	Rejection of 150 mV at 9.8 MHz riding upon supply	33		dB
<b>AC ELECTRICAL CHARACTERISTICS</b>					
$f_{C1}$	Maximum Conversion Rate		125	<b>100</b>	MHz (min)
$f_{C2}$	Minimum Conversion Rate		20		MHz
$t_{CL}$	Minimum Clock Low Time			<b>4.5</b>	ns (min)
$t_{CH}$	Minimum Clock High Time			<b>4.5</b>	ns (min)
$t_{OH}$	Output Hold Time	CLK Rise to Data Invalid	4.4		ns
$t_{OD}$	Output Delay	CLK Rise to Data Valid	5.9	<b>8.5</b>	ns (max)
	Pipeline Delay (Latency)		2.5		Clock Cycles
$t_{AD}$	Sampling (Aperture) Delay	CLK Fall to Acquisition of Data	1.5		ns
$t_{AJ}$	Aperture Jitter		2		ps rms

**Note 1:** Absolute Maximum Ratings indicate limits beyond which damage to the device may occur. Operating Ratings indicate conditions for which the device is functional, but do not guarantee specific performance limits. For guaranteed specifications and test conditions, see the Electrical Characteristics. The guaranteed specifications apply only for the test conditions listed. Some performance characteristics may degrade when the device is not operated under the listed test conditions.

**Note 2:** All voltages are measured with respect to GND = AGND = DR GND = 0V, unless otherwise specified.

**Note 3:** When the input voltage at any pin exceeds the power supplies (that is, less than AGND or DR GND, or greater than  $V_A$  or DR  $V_D$ ), the current at that pin should be limited to 25 mA. The 50 mA maximum package input current rating limits the number of pins that can safely exceed the power supplies with an input current of 25 mA to two.

**Note 4:** The Electrical characteristics tables list guaranteed specifications under the listed Recommended Conditions except as otherwise modified or specified by the Electrical Characteristics Conditions and/or Notes. Typical specifications are estimations for room temperature only and are not guaranteed.

**Note 5:** The absolute maximum junction temperature ( $T_{Jmax}$ ) for this device is 150°C. The maximum allowable power dissipation is dictated by  $T_{Jmax}$ , the junction-to-ambient thermal resistance ( $\theta_{JA}$ ), and the ambient temperature ( $T_A$ ), and can be calculated using the formula  $P_{DMAX} = (T_{Jmax} - T_A) / \theta_{JA}$ . In the 24-pin TSSOP,  $\theta_{JA}$  is 92°C/W. The power consumption of this device under normal operating conditions is far below the package limit, which will be reached only when the ADC08100 is operated in a severe fault condition (e.g., when input or output pins are driven beyond the power supply voltages, or the power supply polarity is reversed). Obviously, such conditions should always be avoided.

**Note 6:** Human body model is 100 pF capacitor discharged through a 1.5 kΩ resistor. Machine model is 220 pF discharged through ZERO Ohms.

**Note 7:** See AN-450, "Surface Mounting Methods and Their Effect on Product Reliability", or the section entitled "Surface Mount" found in any post 1986 National Semiconductor Linear Data Book, for other methods of soldering surface mount devices.

**Note 8:** The analog inputs are protected as shown below. Input voltage magnitudes up to  $V_A + 300 \text{ mV}$  or to 300 mV below GND will not damage this device. However, errors in the A/D conversion can occur if the input goes above DR  $V_D$  or below GND by more than 100 mV. For example, if  $V_A$  is  $2.7V_{DC}$  the full-scale input voltage must be  $\leq 2.6V_{DC}$  to ensure accurate conversions.

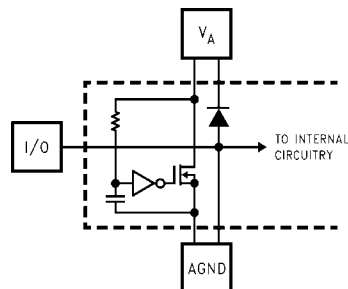

10137107

**Note 9:** To guarantee accuracy, it is required that  $V_A$  and DR  $V_D$  be well bypassed. Each supply pin must be decoupled with separate bypass capacitors.

**Note 10:** Typical figures represent most likely parametric norms at  $T_J = 25^\circ\text{C}$ . Test limits are guaranteed to National's AOQL (Average Outgoing Quality Level).

**Note 11:**  $I_{DR}$  is the current consumed by the switching of the output drivers and is primarily determined by the load capacitance on the output pins, the supply voltage,  $V_{DR}$ , and the rate at which the outputs are switching (which is signal dependent),  $I_{DR} = V_{DR} (C_O \times f_O + C_1 \times f_1 + \dots + C_{71} \times f_7)$  where  $V_{DR}$  is the output driver power supply voltage,  $C_n$  is the total capacitance on any given output pin, and  $f_n$  is the average frequency at which that pin is toggling.

## Specification Definitions

**APERTURE (SAMPLING) DELAY** is that time required after the fall of the clock input for the sampling switch to open. The Sample/Hold circuit effectively stops capturing the input signal and goes into the "hold" mode  $t_{AD}$  after the clock goes low.

**APERTURE JITTER** is the variation in aperture delay from sample to sample. Aperture jitter shows up as input noise.

**BOTTOM OFFSET** is the difference between the input voltage that just causes the output code to transition to the first code and the negative reference voltage. Bottom Offset is defined as  $E_{OB} = V_{ZT} - V_{RB}$ , where  $V_{ZT}$  is the first code transition input voltage.  $V_{RB}$  is the lower reference voltage. Note that this is different from the normal Zero Scale Error.

**CLOCK DUTY CYCLE** is the ratio of the time that the clock waveform is at a logic high to the total time of one clock period.

**DIFFERENTIAL NON-LINEARITY (DNL)** is the measure of the maximum deviation from the ideal step size of 1 LSB. Measured at 100 Msps with a ramp input.

**EFFECTIVE NUMBER OF BITS (ENOB, or EFFECTIVE BITS)** is another method of specifying Signal-to-Noise and Distortion Ratio, or SINAD. ENOB is defined as  $(\text{SINAD} - 1.76) / 6.02$  and says that the converter is equivalent to a perfect ADC of this (ENOB) number of bits.

**FULL POWER BANDWIDTH** is a measure of the frequency at which the reconstructed output fundamental drops 3 dB below its low frequency value for a full scale input. The test is performed with  $f_{IN}$  equal to 100 kHz plus integer multiples of  $f_{CLK}$ . The input frequency at which the output is -3 dB relative to the low frequency input signal is the full power bandwidth.

**FULL-SCALE ERROR** is a measure of how far the last code transition is from the ideal  $1\frac{1}{2}$  LSB below  $V_{RT}$  and is defined as:

$$V_{\max} + 1.5 \text{ LSB} - V_{RT}$$

where  $V_{\max}$  is the voltage at which the transition to the maximum (full scale) code occurs.

**INTEGRAL NON-LINEARITY (INL)** is a measure of the deviation of each individual code from a line drawn from zero scale ( $\frac{1}{2}$  LSB below the first code transition) through positive full scale ( $\frac{1}{2}$  LSB above the last code transition). The deviation of any given code from this straight line is measured from the center of that code value. The end point test method is used. Measured at 100 Msps with a ramp input.

**INTERMODULATION DISTORTION (IMD)** is the creation of additional spectral components as a result of two sinusoidal frequencies being applied to the ADC input at the same time. It is defined as the ratio of the power in the second and third

order intermodulation products to the power in one of the original frequencies. IMD is usually expressed in dBFS.

**MISSING CODE** are those output codes that are skipped and will never appear at the ADC outputs. These codes cannot be reached with any input value.

**OUTPUT DELAY** is the time delay after the rising edge of the input clock before the data update is present at the output pins.

**OUTPUT HOLD TIME** is the length of time that the output data is valid after the rise of the input clock.

**PIPELINE DELAY (LATENCY)** is the number of clock cycles between initiation of conversion and when that data is presented to the output driver stage. New data is available at every clock cycle, but the data lags the conversion by the Pipeline Delay plus the Output Delay.

**SIGNAL TO NOISE RATIO (SNR)** is the ratio, expressed in dB, of the rms value of the input signal at the output to the rms value of the sum of all other spectral components below one-half the sampling frequency, not including harmonics or DC.

**SIGNAL TO NOISE PLUS DISTORTION (S/(N+D) or SINAD)** is the ratio, expressed in dB, of the rms value of the input signal at the output to the rms value of all of the other spectral components below half the clock frequency, including harmonics but excluding D.C.

**SPURIOUS FREE DYNAMIC RANGE (SFDR)** is the difference, expressed in dB, between the rms values of the input signal at the output and the peak spurious signal, where a spurious signal is any signal present in the output spectrum that is not present at the input.

**TOTAL HARMONIC DISTORTION (THD)** is the ratio, expressed in dB, of the total of the first nine harmonic levels at the output to the level of the fundamental at the output. THD is calculated as

$$\text{THD} = 20 \times \log \sqrt{\frac{f_2^2 + f_3^2 + f_4^2 + f_5^2 + f_6^2 + f_7^2 + f_8^2 + f_9^2 + f_{10}^2}{f_1^2}}$$

where  $F_1$  is the RMS power of the fundamental (input) frequency and  $f_2$  through  $f_{10}$  is the power in the first 9 harmonics in the output spectrum.

**ZERO SCALE OFFSET ERROR** is the error in the input voltage required to cause the first code transition. It is defined as

$$V_{\text{OFF}} = V_{ZT} - V_{RB}$$

where  $V_{ZT}$  is the first code transition input voltage.

# Timing Diagram

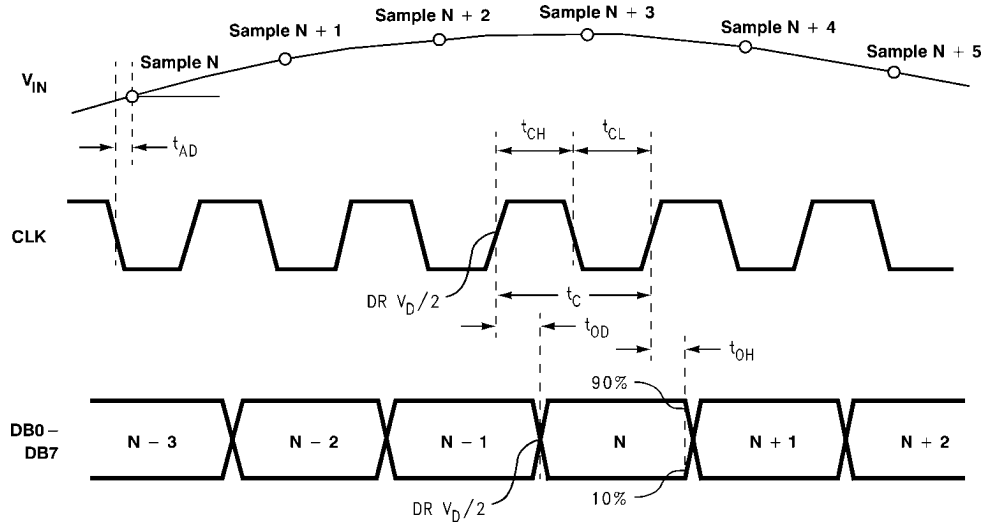

10137131

FIGURE 1. ADC08100 Timing Diagram



# Typical Performance Characteristics

stated

$V_A = DR$   $V_D = 3V$ ,  $f_{CLK} = 100$  MHz,  $f_{IN} = 41$  MHz, unless otherwise

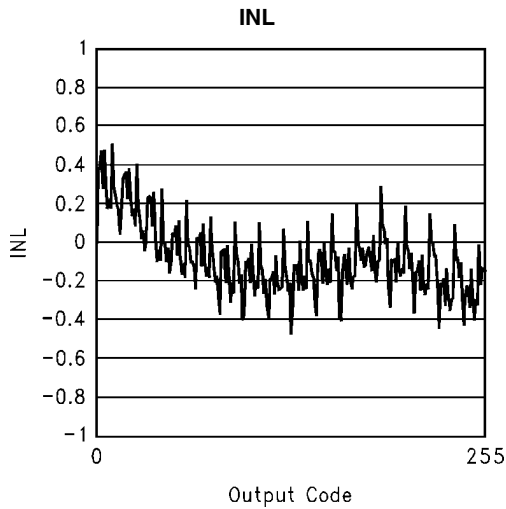

10137108

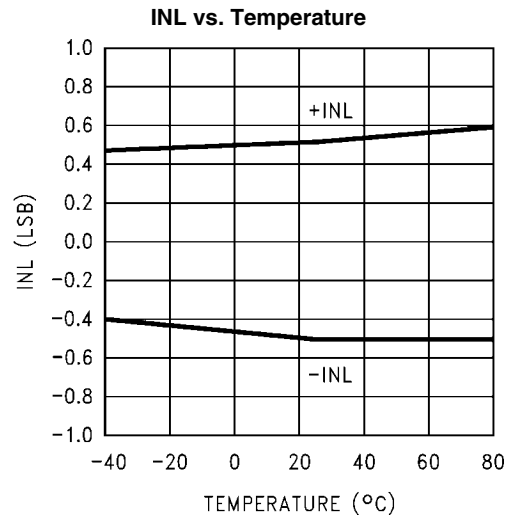

10137114

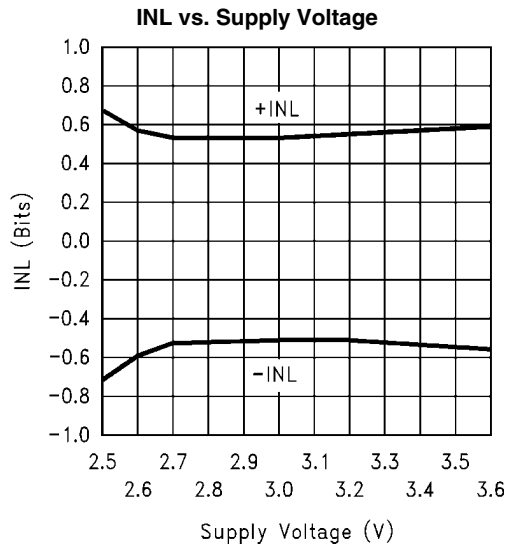

10137115

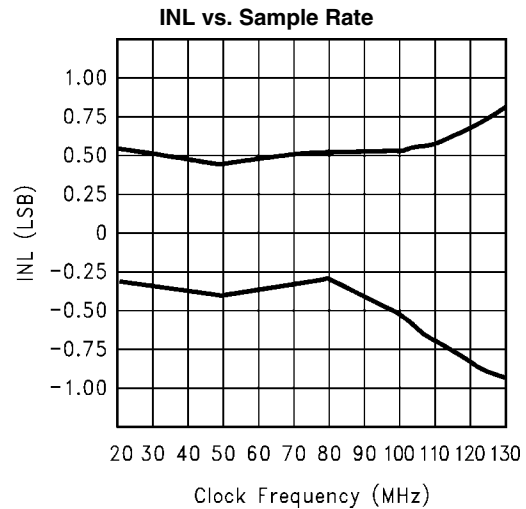

10137110

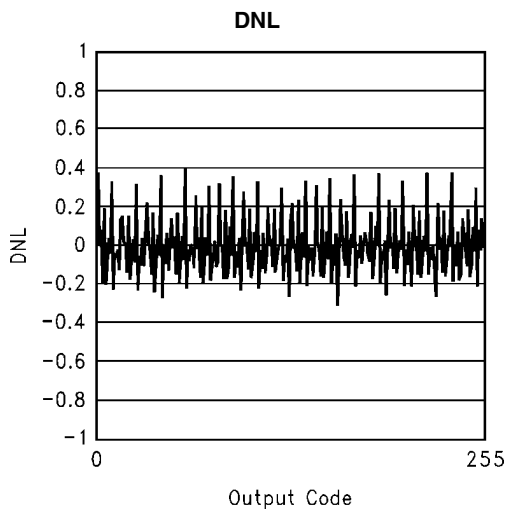

10137109

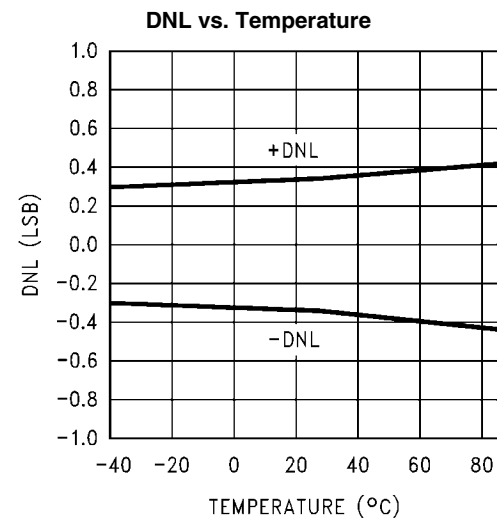

10137117

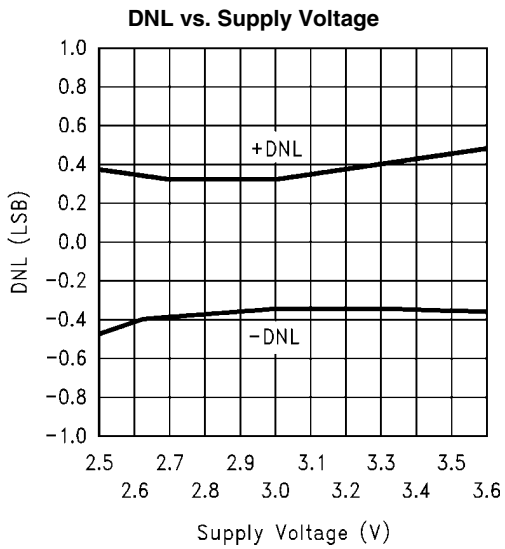

10137118

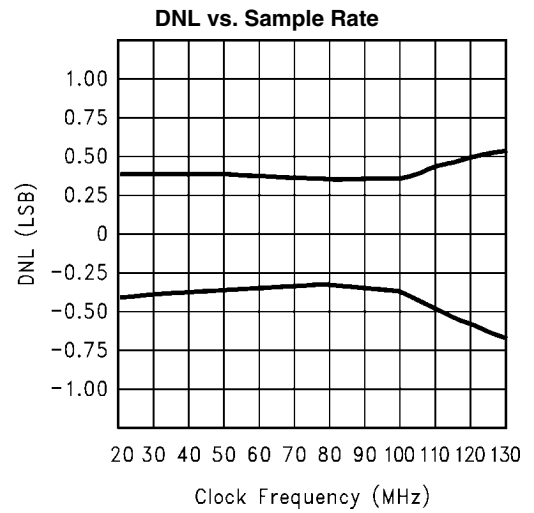

10137111

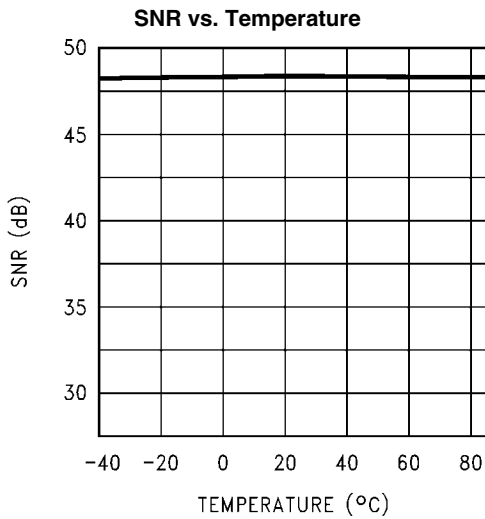

10137120

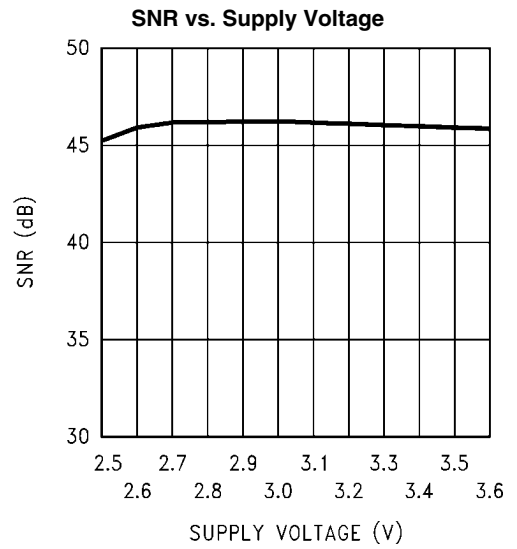

10137121

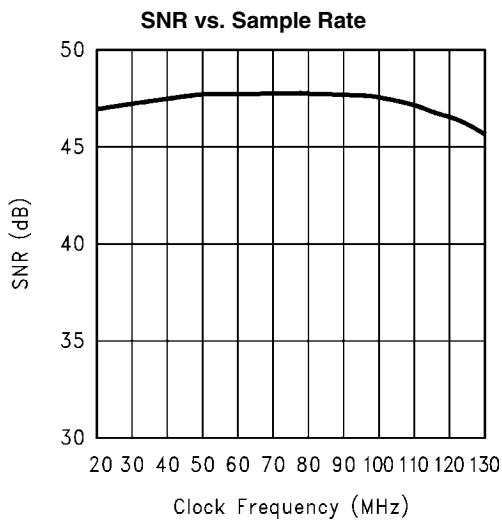

10137112

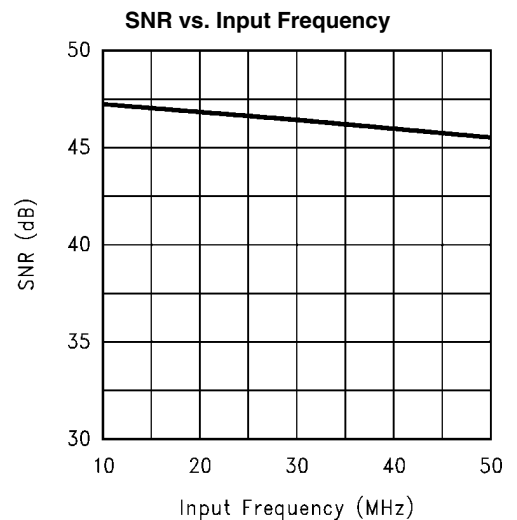

10137123

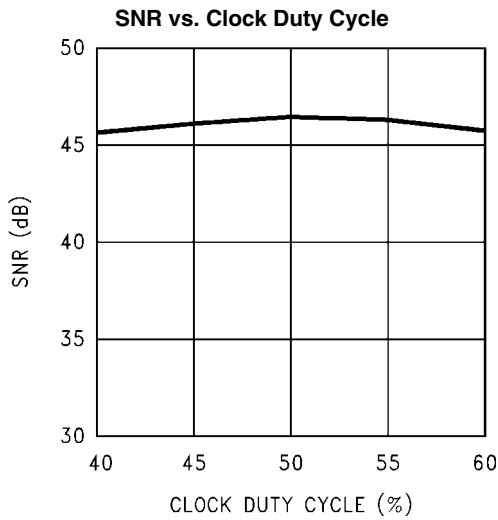

10137124

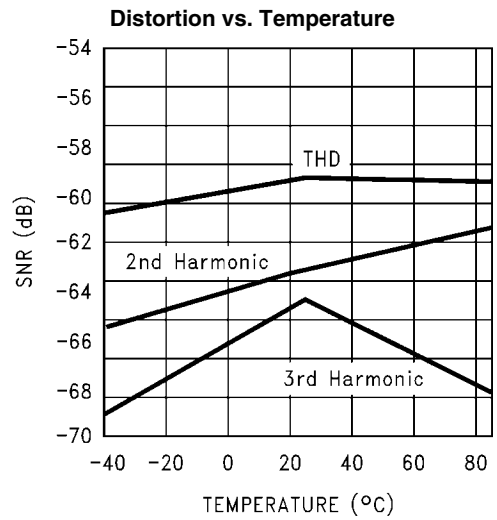

10137125

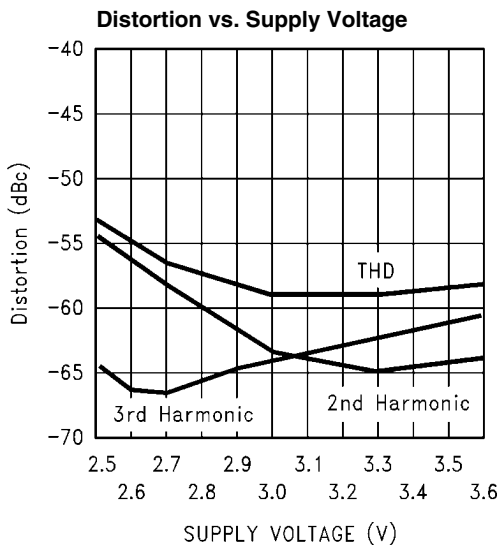

10137126

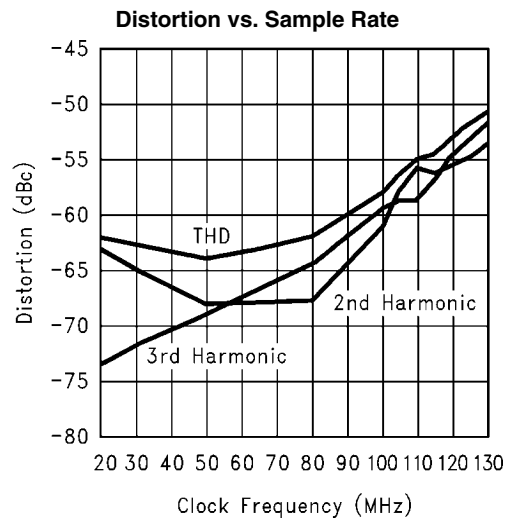

10137113

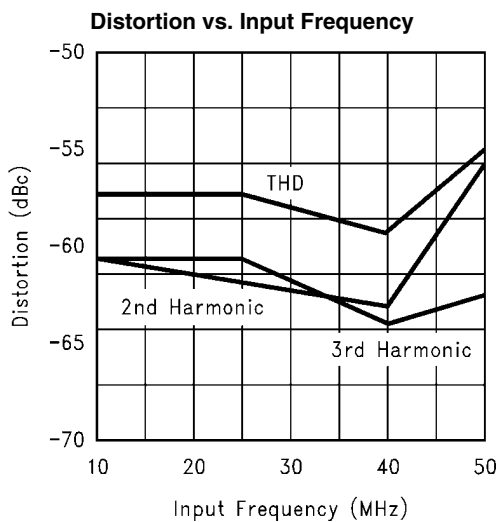

10137128

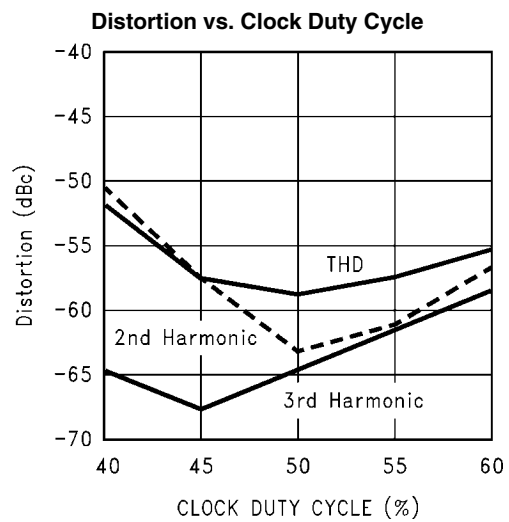

10137129

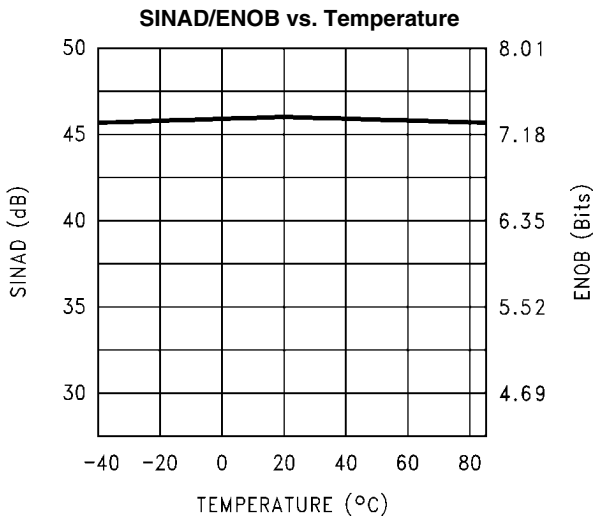

10137130

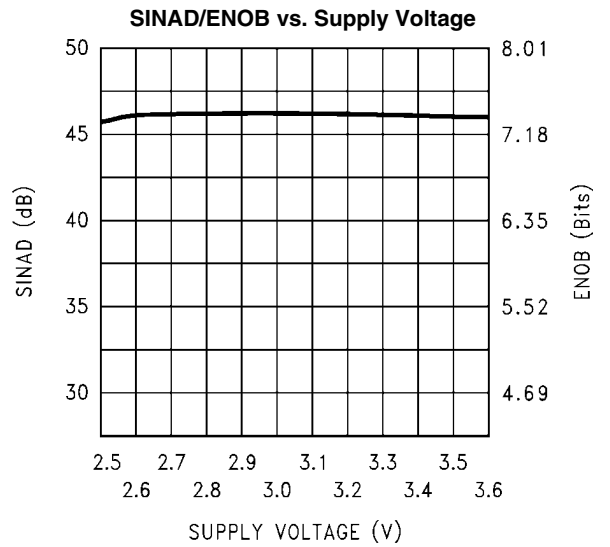

10137138

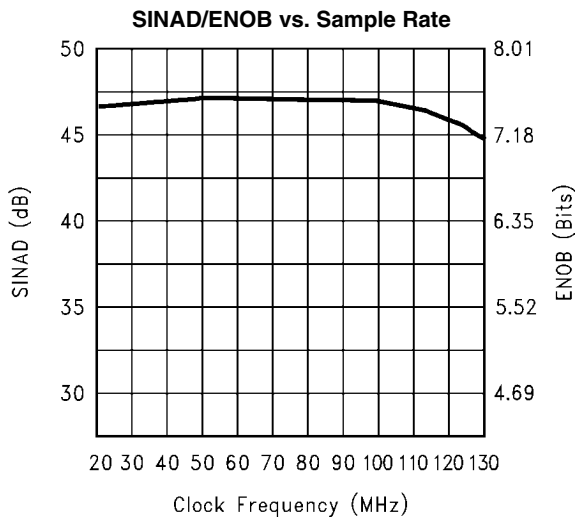

10137116

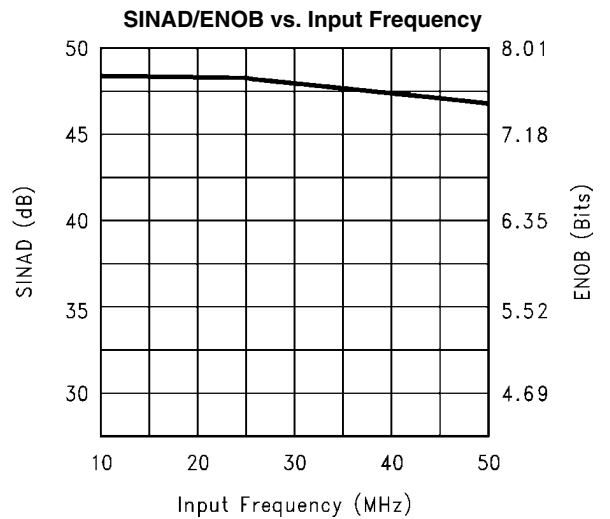

10137139

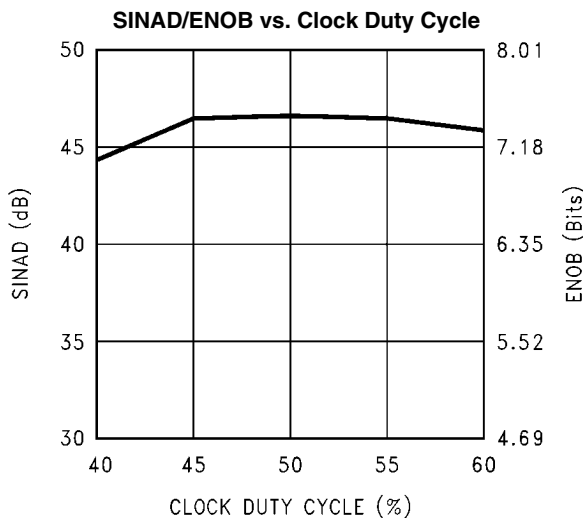

10137140

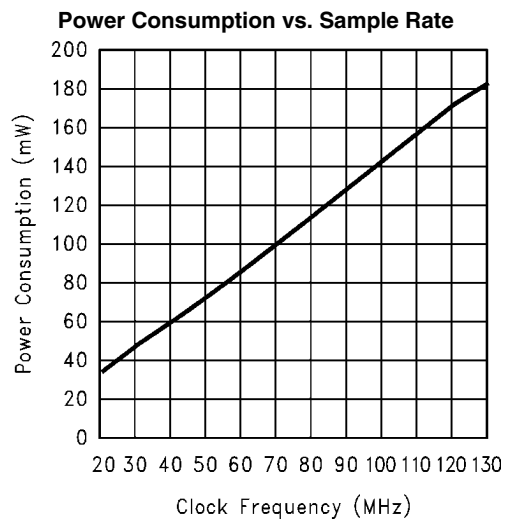

10137119

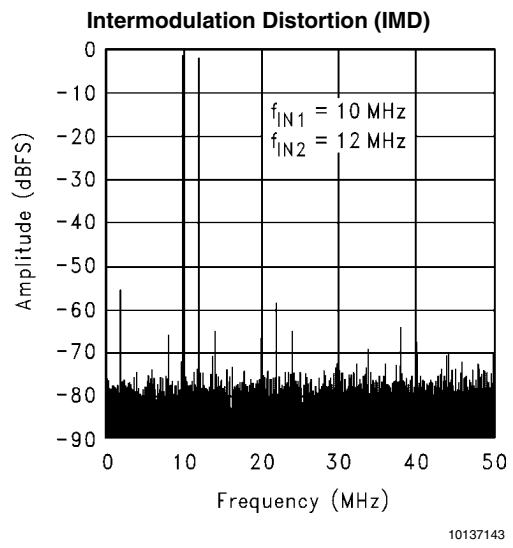
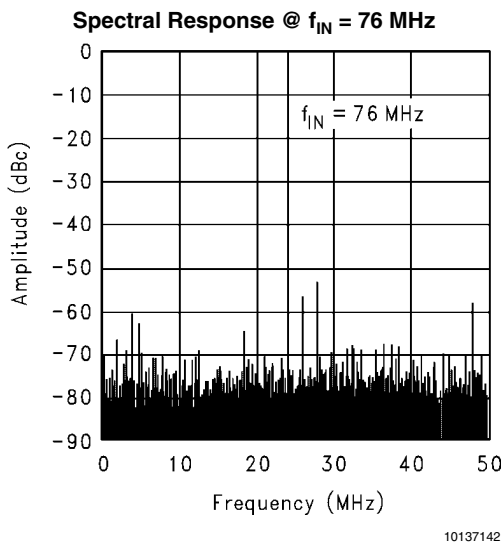
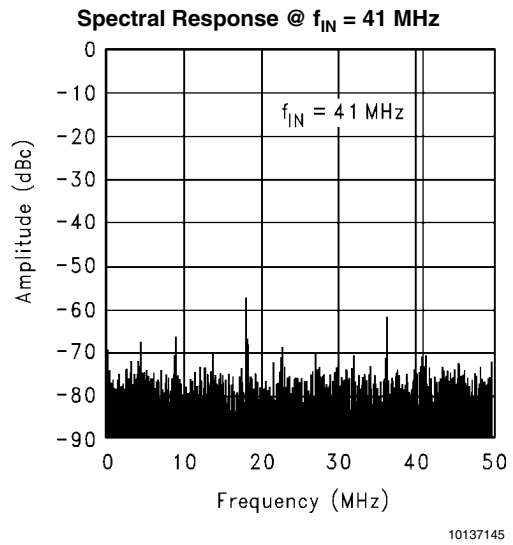
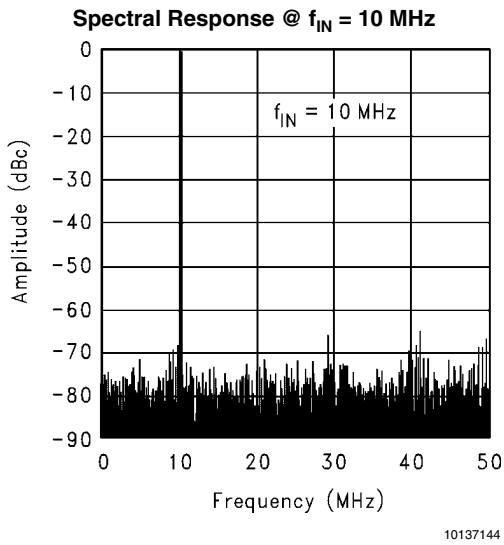

## Functional Description

The ADC08100 uses a new, unique architecture that achieves over 7 effective bits at input frequencies up to and beyond 50 MHz.

The analog input signal that is within the voltage range set by  $V_{RT}$  and  $V_{RB}$  is digitized to eight bits. Input voltages below  $V_{RB}$  will cause the output word to consist of all zeroes. Input voltages above  $V_{RB}$  will cause the output word to consist of all ones.

Incorporating a switched capacitor bandgap, the ADC08100 exhibits a power consumption that is proportional to frequency, limiting power consumption to what is needed at the clock rate that is used. This and its excellent performance over a wide range of clock frequencies makes it an ideal choice as a single ADC for many 8-bit needs.

Data is acquired at the falling edge of the clock and the digital equivalent of that data is available at the digital outputs 2.5 clock cycles plus  $t_{OD}$  later. The ADC08100 will convert as long as the clock signal is present. The output coding is straight binary.

The device is in the active state when the Power Down pin (PD) is low. When the PD pin is high, the device is in the power down mode, where the output pins hold the last conversion before the PD pin went high and the device consumes just 1 mW.

## Applications Information

### 1.0 REFERENCE INPUTS

The reference inputs  $V_{RT}$  and  $V_{RB}$  are the top and bottom of the reference ladder, respectively. Input signals between these two voltages will be digitized to 8 bits. External voltages

applied to the reference input pins should be within the range specified in the Operating Ratings table. Any device used to drive the reference pins should be able to source sufficient current into the  $V_{RT}$  pin and sink sufficient current from the  $V_{RB}$  pin.

The reference bias circuit of *Figure 2* is very simple and the performance is adequate for many applications. However, circuit tolerances will lead to a wide reference voltage range. Superior performance can generally be achieved by driving the reference pins with low impedance sources.

The circuit of *Figure 3* will allow a more accurate setting of the reference voltages. The upper amplifier must be able to source the reference current as determined by the value of the reference resistor and the value of  $(V_{RT} - V_{RB})$ . The lower amplifier must be able to sink this reference current. Both should be stable with a capacitive load. The *LM8272* was chosen because of its rail-to-rail input and output capability, its high current output and its ability to drive large capacitance loads.

The divider resistors at the inputs to the amplifiers could be changed to suit the application reference voltage needs, or the divider can be replaced with potentiometers or DACs for precise settings. The bottom of the ladder ( $V_{RB}$ ) may be returned to ground if the minimum input signal excursion is 0V.

$V_{RT}$  should always be more positive than  $V_{RB}$  by the minimum  $V_{RT} - V_{RB}$  difference in the Electrical Characteristics table to minimize noise. Furthermore, the difference between  $V_{RT}$  and  $V_{RB}$  should not exceed the maximum value specified in the Electrical Characteristics table to avoid signal distortion.

The  $V_{RM}$  pin is the center of the reference ladder and should be bypassed to a clean, quiet point in the analog ground plane with a 0.1  $\mu\text{F}$  capacitor. DO NOT allow this pin to float.

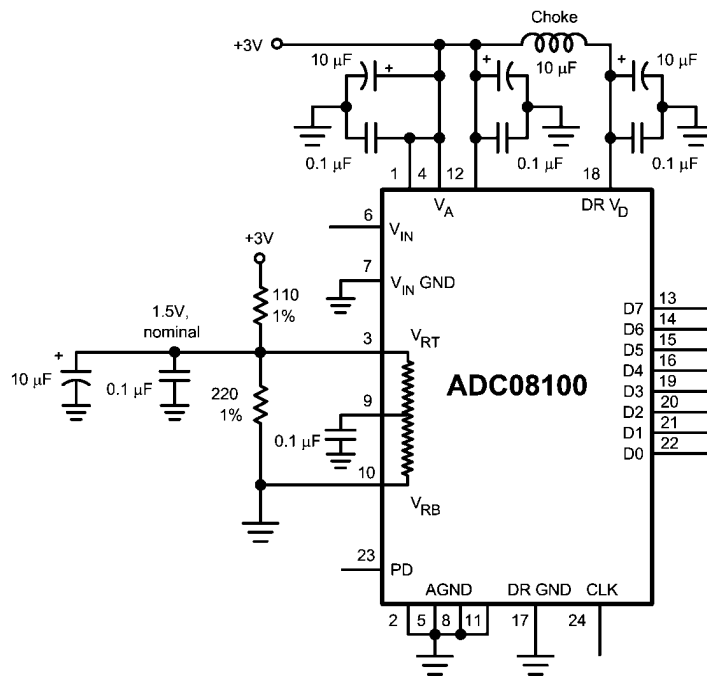

10137132

**FIGURE 2. Simple, low component count reference biasing. Because of the ladder and external resistor tolerances, the reference voltage can vary too much for some applications.**

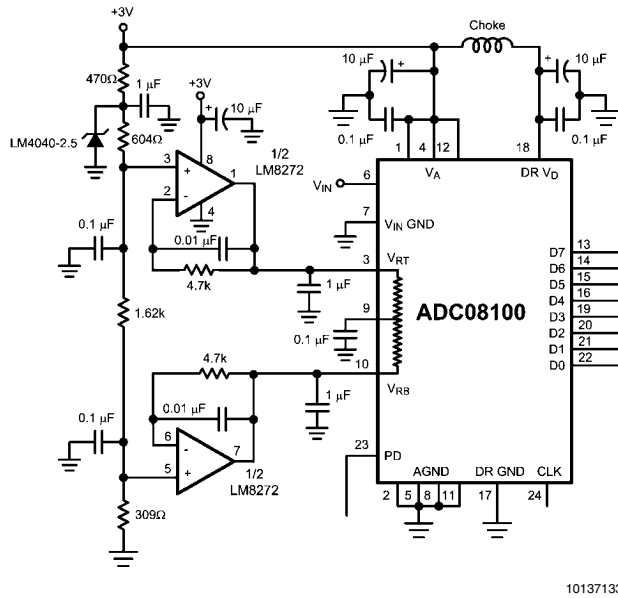

FIGURE 3. Driving the reference to force desired values requires driving with a low impedance source.

2.0 THE ANALOG INPUT

The analog input of the ADC08100 is a switch followed by an integrator. The input capacitance changes with the clock level, appearing as 3 pF when the clock is low, and 4 pF when the clock is high. The sampling nature of the analog input causes current spikes at the input that result in voltage spikes there. Any amplifier used to drive the analog input must be able to settle within the clock high time. The LMH6702 and the LMH6628 have been found to be good amplifiers to drive the ADC08100.

Figure 4 shows an example of an input circuit using the LMH6702. Any input amplifier should incorporate some gain as operational amplifiers exhibit better phase margin and transient response with gains above 2 or 3 than with unity gain. If an overall gain of less than 3 is required, attenuate the input and operate the amplifier at a higher gain, as shown in Figure 4.

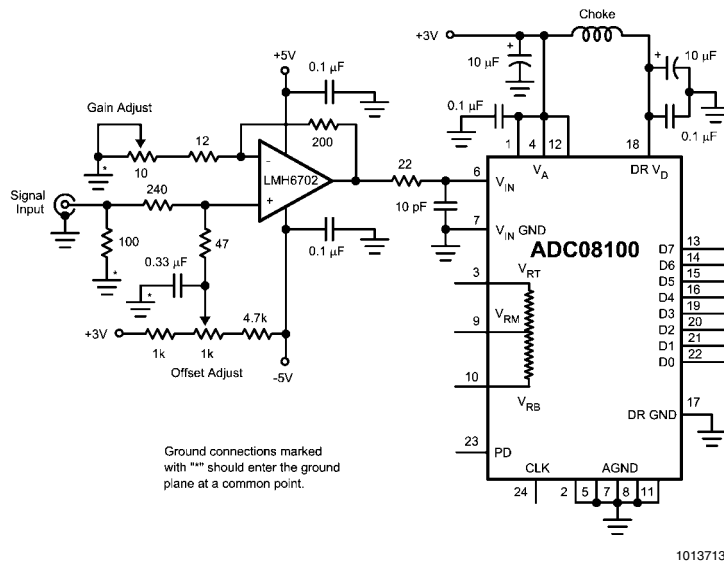

FIGURE 4. The input amplifier should incorporate some gain for best performance (see text).

The RC at the amplifier output filters the clock rate energy that comes out of the analog input due to the input sampling circuit. The optimum time constant for this circuit depends not only upon the amplifier and ADC, but also on the circuit layout and board material. A resistor value should be chosen between

18Ω and 47Ω and the capacitor value chose according to the formula

$$C = \frac{1}{2 \cdot \pi \cdot R \cdot f_{CLK}}$$

The value of "C" in the formula above should include the ADC input capacitance when the clock is high.

This will provide optimum SNR performance for Nyquist applications. Best THD performance is realized when the capacitor and resistor values are both zero, but this would compromise SNR and SINAD performance. Generally, there should be no resistor or capacitor between the ADC input and any amplifier for undersampling applications.

The circuit of *Figure 4* has both gain and offset adjustments. If you eliminate these adjustments normal circuit tolerances may cause signal clipping unless care is exercised in the worst case analysis of component tolerance and the input signal excursion is appropriately limited to account for the worst case conditions. Of course, this means that the designer will not be able to depend upon getting a full scale output with maximum signal input.

Full scale and offset adjustments may also be made by adjusting  $V_{RT}$  and  $V_{RB}$ , perhaps with the aid of a pair of DACs.

### 3.0 POWER SUPPLY CONSIDERATIONS

A/D converters draw sufficient transient current to corrupt their own power supplies if not adequately bypassed. A 10  $\mu$ F tantalum or aluminum electrolytic capacitor should be placed within an inch (2.5 cm) of the A/D power pins, with a 0.1  $\mu$ F ceramic chip capacitor placed within one centimeter of the converter's power supply pins. Leadless chip capacitors are preferred because they have low lead inductance.

While a single voltage source is recommended for the  $V_A$  and DR  $V_D$  supplies of the ADC08100, these supply pins should be well isolated from each other to prevent any digital noise from being coupled into the analog portions of the ADC. A choke or 27 $\Omega$  resistor is recommended between these supply lines with adequate bypass capacitors close to the supply pins.

As is the case with all high speed converters, the ADC08100 should be assumed to have little power supply rejection. None of the supplies for the converter should be the supply that is used for other digital circuitry in any system with a lot of digital power being consumed. The ADC supplies should be the same supply used for other analog circuitry.

No pin should ever have a voltage on it that is in excess of the supply voltage or below ground by more than 300 mV, not even on a transient basis. This can be a problem upon application of power and power shut-down. Be sure that the supplies to circuits driving any of the input pins, analog or digital, do not come up any faster than does the voltage at the ADC08100 power pins.

### 4.0 THE DIGITAL INPUT PINS

The ADC08100 has two digital input pins: The PD pin and the Clock pin.

#### 4.1 The PD Pin

The Power Down (PD) pin, when high, puts the ADC08100 into a low power mode where power consumption is reduced to 1 mW. Output data is valid and accurate about 1 microsecond after the PD pin is brought low.

The digital output pins retain the last conversion output code when either the clock is stopped or the PD pin is high.

#### 4.2 The ADC08100 Clock

Although the ADC08100 is tested and its performance is guaranteed with a 100 MHz clock, it typically will function well with clock frequencies from 20 MHz to 125 MHz.

Halting the clock will provide nearly as much power saving as raising the PD pin high. Typical power consumption with a

stopped clock is 3 mW, compared to 1 mW when PD is high. The digital outputs will remain in the same state as they were before the clock was halted.

Once the clock is restored (or the PD pin is brought low), there is a time of about 1 microsecond before the output data is valid. However, because of the linear relationship between total power consumption and clock frequency, the part requires about one microsecond after the clock is restarted or substantially changed in frequency before the part returns to its specified accuracy.

The low and high times of the clock signal can affect the performance of any A/D Converter. Because achieving a precise duty cycle is difficult, the ADC08100 is designed to maintain performance over a range of duty cycles. While it is specified and performance is guaranteed with a 50% clock duty cycle and 100 Msps, ADC08100 performance is typically maintained with clock high and low times of 2 ns, corresponding to a clock duty cycle range of 20% to 80% with a 100 MHz clock. Note that the clock high and low times of 2 ns may not be asserted together.

The **CLOCK** line should be series terminated at the clock source in the characteristic impedance of that line. If the clock line is longer than

$$\frac{t_r}{6 \times t_{PD}}$$

where  $t_r$  is the clock rise time and  $t_{PD}$  is the propagation rate of the signal along the trace, the **CLOCK** pin should be a.c. terminated with a series RC to ground such that the resistor value is equal to the characteristic impedance of the clock line and the capacitor value is

$$C \geq \frac{4 \times t_{PD} \times L}{Z_o}$$

where  $t_{PD}$  is the signal propagation rate down the clock line, "L" is the line length and  $Z_o$  is the characteristic impedance of the clock line. This termination should be located as close as possible to, but within one centimeter of, the ADC08100 clock pin. Typical  $t_{PD}$  is about 150 ps/inch on FR-4 board material. For FR-4 board material, the value of C becomes

$$C \geq \frac{6 \times 10^{-10} \times L}{Z_o}$$

where L is the length of the clock line in inches.

### 5.0 LAYOUT AND GROUNDING

Proper grounding and proper routing of all signals are essential to ensure accurate conversion. A combined analog and digital ground plane should be used.

Since digital switching transients are composed largely of high frequency components, total ground plane copper weight will have little effect upon the logic-generated noise because of the skin effect. Total surface area is more important than is total ground plane volume. Capacitive coupling between the typically noisy digital circuitry and the sensitive analog circuitry can lead to poor performance that may seem impossible to isolate and remedy. The solution is to keep the analog circuitry well separated from the digital circuitry.

High power digital components should not be located on or near a straight line between the ADC or any linear component and the power supply area as the resulting common return



current path could cause fluctuation in the analog input “ground” return of the ADC.

The DR Gnd connection to the ground plane should not use the same feedthrough use by other ground connections.

Generally, analog and digital lines should cross each other at 90° to avoid getting digital noise into the analog path. In high frequency systems, however, avoid crossing analog and digital lines altogether. Clock lines should be isolated from ALL other lines, analog AND digital. Even the generally accepted 90° crossing should be avoided as even a little coupling can cause problems at high frequencies. Best performance at high frequencies is obtained with a straight signal path.

The analog input should be isolated from noisy signal traces to avoid coupling of spurious signals into the input. Any external component (e.g., a filter capacitor) connected between the converter's input and ground should be connected to a very clean point in the analog ground plane.

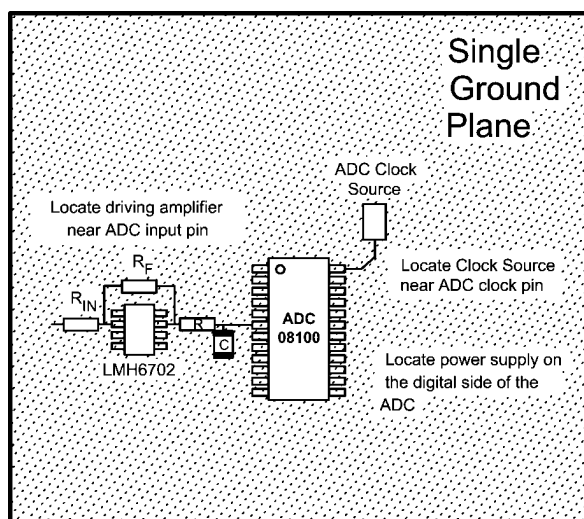

10137136

**FIGURE 5. Layout Example**

Figure 5 gives an example of a suitable layout. All analog circuitry (input amplifiers, filters, reference components, etc.) should be placed together away from any digital components.

## 6.0 DYNAMIC PERFORMANCE

The ADC08100 is AC tested and its dynamic performance is guaranteed. To meet the published specifications, the clock source driving the CLK input must exhibit less than 3 ps (rms) of jitter. For best AC performance, isolating the ADC clock from any digital circuitry should be done with adequate buffers, as with a clock tree. See Figure 6.

It is good practice to keep the ADC clock line as short as possible and to keep it well away from any other signals. Other signals can introduce jitter into the clock signal. The clock signal can also introduce noise into the analog path.

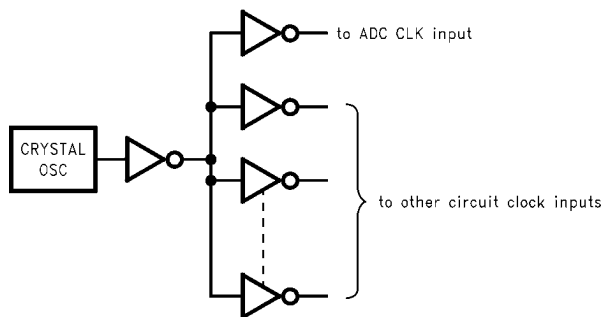

10137137

**FIGURE 6. Isolating the ADC Clock from Digital Circuitry**

## 7.0 COMMON APPLICATION PITFALLS

**Driving the inputs (analog or digital) beyond the power supply rails.** For proper operation, all inputs should not go more than 300 mV below the ground pins or 300 mV above the supply pins. Exceeding these limits on even a transient basis may cause faulty or erratic operation. It is not uncommon for high speed digital circuits (e.g., 74F and 74AC devices) to exhibit undershoot that goes more than a volt below ground. A 51Ω resistor in series with the offending digital input will usually eliminate the problem.

Care should be taken not to overdrive the inputs of the ADC08100. Such practice may lead to conversion inaccuracies and even to device damage.

**Attempting to drive a high capacitance digital data bus.**

The more capacitance the output drivers must charge for each conversion, the more instantaneous digital current is required from DR  $V_D$  and DR GND. These large charging current spikes can couple into the analog section, degrading dynamic performance. Buffering the digital data outputs (with a 74F541, for example) may be necessary if the data bus capacitance exceeds 10 pF. Dynamic performance can also be improved by adding 100Ω series resistors at each digital output, reducing the energy coupled back into the converter input pins.

**Using an inadequate amplifier to drive the analog input.**

As explained in Section 2.0, the capacitance seen at the input alternates between 3 pF and 4 pF with the clock. This dynamic capacitance is more difficult to drive than is a fixed capacitance, and should be considered when choosing a driving device. The LMH6702 and the LMH6628 have been found to be good devices for driving the ADC08100.

**Driving the  $V_{RT}$  pin or the  $V_{RB}$  pin with devices that cannot source or sink the current required by the ladder.** As mentioned in Section 1.0, care should be taken to see that any driving devices can source sufficient current into the  $V_{RT}$  pin and sink sufficient current from the  $V_{RB}$  pin. If these pins are not driven with devices that can handle the required current, these reference pins will not be stable, resulting in a reduction of dynamic performance.

**Using a clock source with excessive jitter, using an excessively long clock signal trace, or having other signals coupled to the clock signal trace.** This will cause the sampling interval to vary, causing excessive output noise and a reduction in SNR performance. The use of simple gates with RC timing is generally inadequate as a clock source.

**Physical Dimensions** inches (millimeters) unless otherwise noted

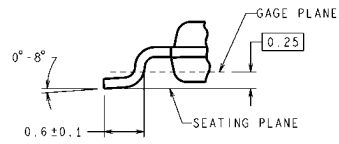
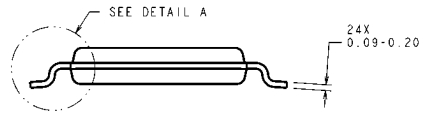
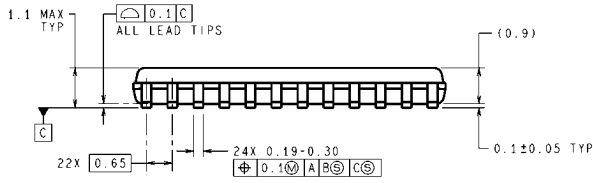
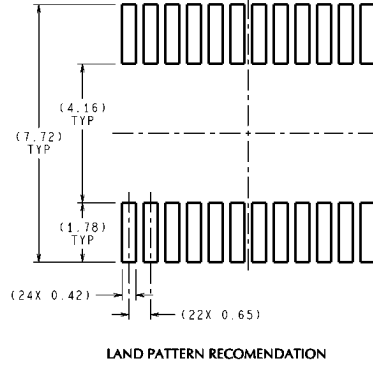
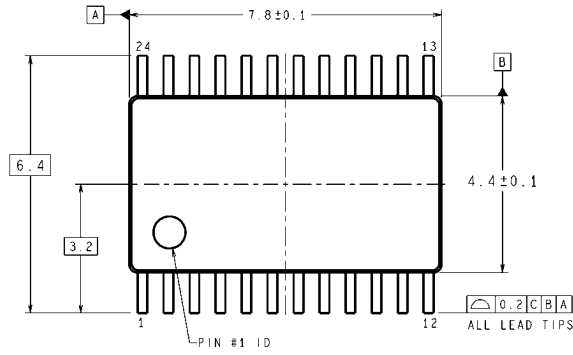

DIMENSIONS ARE IN MILLIMETERS

DETAIL A  
TYPICAL

MTC24 (Rev E)

NOTES: UNLESS OTHERWISE SPECIFIED

REFERENCE JEDEC REGISTRATION mo-153, VARIATION AD, DATED 7/93.

**24-Lead Package TC**  
**Order Number ADC08100CIMTC**  
**NS Package Number MTC24**

# Notes

## Notes

For more National Semiconductor product information and proven design tools, visit the following Web sites at:

Products		Design Support	
Amplifiers	<a href="http://www.national.com/amplifiers">www.national.com/amplifiers</a>	WEBENCH	<a href="http://www.national.com/webench">www.national.com/webench</a>
Audio	<a href="http://www.national.com/audio">www.national.com/audio</a>	Analog University	<a href="http://www.national.com/AU">www.national.com/AU</a>
Clock Conditioners	<a href="http://www.national.com/timing">www.national.com/timing</a>	App Notes	<a href="http://www.national.com/appnotes">www.national.com/appnotes</a>
Data Converters	<a href="http://www.national.com/adc">www.national.com/adc</a>	Distributors	<a href="http://www.national.com/contacts">www.national.com/contacts</a>
Displays	<a href="http://www.national.com/displays">www.national.com/displays</a>	Green Compliance	<a href="http://www.national.com/quality/green">www.national.com/quality/green</a>
Ethernet	<a href="http://www.national.com/ethernet">www.national.com/ethernet</a>	Packaging	<a href="http://www.national.com/packaging">www.national.com/packaging</a>
Interface	<a href="http://www.national.com/interface">www.national.com/interface</a>	Quality and Reliability	<a href="http://www.national.com/quality">www.national.com/quality</a>
LVDS	<a href="http://www.national.com/lvds">www.national.com/lvds</a>	Reference Designs	<a href="http://www.national.com/refdesigns">www.national.com/refdesigns</a>
Power Management	<a href="http://www.national.com/power">www.national.com/power</a>	Feedback	<a href="http://www.national.com/feedback">www.national.com/feedback</a>
Switching Regulators	<a href="http://www.national.com/switchers">www.national.com/switchers</a>		
LDOs	<a href="http://www.national.com/lido">www.national.com/lido</a>		
LED Lighting	<a href="http://www.national.com/led">www.national.com/led</a>		
PowerWise	<a href="http://www.national.com/powerwise">www.national.com/powerwise</a>		
Serial Digital Interface (SDI)	<a href="http://www.national.com/sdi">www.national.com/sdi</a>		
Temperature Sensors	<a href="http://www.national.com/tempsensors">www.national.com/tempsensors</a>		
Wireless (PLL/VCO)	<a href="http://www.national.com/wireless">www.national.com/wireless</a>		

THE CONTENTS OF THIS DOCUMENT ARE PROVIDED IN CONNECTION WITH NATIONAL SEMICONDUCTOR CORPORATION ("NATIONAL") PRODUCTS. NATIONAL MAKES NO REPRESENTATIONS OR WARRANTIES WITH RESPECT TO THE ACCURACY OR COMPLETENESS OF THE CONTENTS OF THIS PUBLICATION AND RESERVES THE RIGHT TO MAKE CHANGES TO SPECIFICATIONS AND PRODUCT DESCRIPTIONS AT ANY TIME WITHOUT NOTICE. NO LICENSE, WHETHER EXPRESS, IMPLIED, ARISING BY ESTOPPEL OR OTHERWISE, TO ANY INTELLECTUAL PROPERTY RIGHTS IS GRANTED BY THIS DOCUMENT.

TESTING AND OTHER QUALITY CONTROLS ARE USED TO THE EXTENT NATIONAL DEEMS NECESSARY TO SUPPORT NATIONAL'S PRODUCT WARRANTY. EXCEPT WHERE MANDATED BY GOVERNMENT REQUIREMENTS, TESTING OF ALL PARAMETERS OF EACH PRODUCT IS NOT NECESSARILY PERFORMED. NATIONAL ASSUMES NO LIABILITY FOR APPLICATIONS ASSISTANCE OR BUYER PRODUCT DESIGN. BUYERS ARE RESPONSIBLE FOR THEIR PRODUCTS AND APPLICATIONS USING NATIONAL COMPONENTS. PRIOR TO USING OR DISTRIBUTING ANY PRODUCTS THAT INCLUDE NATIONAL COMPONENTS, BUYERS SHOULD PROVIDE ADEQUATE DESIGN, TESTING AND OPERATING SAFEGUARDS.

EXCEPT AS PROVIDED IN NATIONAL'S TERMS AND CONDITIONS OF SALE FOR SUCH PRODUCTS, NATIONAL ASSUMES NO LIABILITY WHATSOEVER, AND NATIONAL DISCLAIMS ANY EXPRESS OR IMPLIED WARRANTY RELATING TO THE SALE AND/OR USE OF NATIONAL PRODUCTS INCLUDING LIABILITY OR WARRANTIES RELATING TO FITNESS FOR A PARTICULAR PURPOSE, MERCHANTABILITY, OR INFRINGEMENT OF ANY PATENT, COPYRIGHT OR OTHER INTELLECTUAL PROPERTY RIGHT.

### LIFE SUPPORT POLICY

**NATIONAL'S PRODUCTS ARE NOT AUTHORIZED FOR USE AS CRITICAL COMPONENTS IN LIFE SUPPORT DEVICES OR SYSTEMS WITHOUT THE EXPRESS PRIOR WRITTEN APPROVAL OF THE CHIEF EXECUTIVE OFFICER AND GENERAL COUNSEL OF NATIONAL SEMICONDUCTOR CORPORATION.** As used herein:

Life support devices or systems are devices which (a) are intended for surgical implant into the body, or (b) support or sustain life and whose failure to perform when properly used in accordance with instructions for use provided in the labeling can be reasonably expected to result in a significant injury to the user. A critical component is any component in a life support device or system whose failure to perform can be reasonably expected to cause the failure of the life support device or system or to affect its safety or effectiveness.

National Semiconductor and the National Semiconductor logo are registered trademarks of National Semiconductor Corporation. All other brand or product names may be trademarks or registered trademarks of their respective holders.

Copyright© 2008 National Semiconductor Corporation

For the most current product information visit us at [www.national.com](http://www.national.com)



**National Semiconductor  
Americas Technical  
Support Center**  
Email:  
[new.feedback@nsc.com](mailto:new.feedback@nsc.com)  
Tel: 1-800-272-9959

**National Semiconductor Europe  
Technical Support Center**  
Email: [europe.support@nsc.com](mailto:europe.support@nsc.com)  
German Tel: +49 (0) 180 5010 771  
English Tel: +44 (0) 870 850 4288

**National Semiconductor Asia  
Pacific Technical Support Center**  
Email: [ap.support@nsc.com](mailto:ap.support@nsc.com)

**National Semiconductor Japan  
Technical Support Center**  
Email: [jpn.feedback@nsc.com](mailto:jpn.feedback@nsc.com)